

# Diaphragm valve Type 15 125mm, 150mm Manual Type

## User's Manual



Thank you for choosing our product.

This User's manual contains important information for safe use of our product, so please be sure to read it before handling the product. After reading this manual, please be sure to keep it in a place where the user can see it at any time.

**ASAHI YUKIZAI CORPORATION**

**-SAFETY PRECAUTIONS-**



This User's manual is written on the assumption that the person who handles our products has a basic knowledge of our products, electrical equipment, machinery, control, etc., and it contains technical terms depending on the handling contents.

Please read this manual carefully and fully understand the contents and observe the safety precautions for proper use.



In this manual, the warning, caution, prohibition, and enforcement are categorized together with the symbol to inform the situation and scale of human injury or property damage.

Failure to observe this precaution may result in unexpected failure or damage. Be sure to observe this precaution.

**<WARNING/CAUTION indications>**

 <b>Warning</b>	Indicates a potentially hazardous situation which, if not avoided, could result in death or serious injury.
 <b>Caution</b>	Indicates a potentially hazardous situation which, if not avoided, may result in minor or moderate injury or property damage.

**<Prohibited/Forced display>**

 <b>Prohibition</b>	In the handling of the product, it is prohibited to do it in "Do not do it".
 <b>Forcing</b>	In the handling of the product, it is forced by "contents to be carried out without fail".

## Table of contents

<b>1. Our product warranty coverage</b> .....	<b>4</b>
Applicable to .....	4
Warranty Period.....	4
Guaranteed range.....	4
Disclaimer.....	4
<b>2. Safety Instructions</b> .....	<b>5</b>
Unpacking, Transportation and Storage.....	5
Product Handling.....	6
<b>3. Name of each part</b> .....	<b>7</b>
<b>4. Product Specifications</b> .....	<b>9</b>
Model number table.....	9
Relationship between maximum allowable pressure and temperature .....	10
Limit switch specifications .....	11
<b>5. Piping method</b> .....	<b>12</b>
<b>6. Limit switch wiring method</b> .....	<b>14</b>
<b>7. Operation method</b> .....	<b>15</b>
<b>8. How to disassemble/assemble parts for replacement</b> .....	<b>16</b>
<b>9. How to adjust the stopper</b> .....	<b>17</b>
<b>10. Inspection item</b> .....	<b>18</b>
Daily inspection .....	19
Periodic inspection.....	20
<b>11. Cause of malfunction and remedy</b> .....	<b>21</b>
<b>12. Disposal method of residual materials and waste materials</b> .....	<b>22</b>
<b>Inquiries</b> .....	<b>23</b>

## 1. Our product warranty coverage

Unless otherwise stated in the Contract or Specifications, etc., the warranty for the piping material products (hereinafter referred to as "applicable products") such as valves manufactured or sold by us is as follows.

### Applicable to

This warranty applies only when the product is used in Japan. If you intend to use the product overseas, please contact us.

### Warranty Period

The warranty period is one year after delivery.

### Guaranteed range

In the event of failure or malfunction due to our responsibility during the above warranty period, we will replace or repair the product with a substitute free of charge.

Provided, however, that even within the warranty period, the warranty shall not apply to any of the following cases (charged service).



- ▶ When the storage, operating conditions, precautions, etc. described in the specifications, User's manual, etc. are not adhered to in the construction, installation, handling, maintenance, etc.
- ▶ Defects, such as the design of the customer's equipment or software, caused by other than the target product.
- ▶ The fault is due to modification or secondary processing of the product by something other than us.
- ▶ In the case of a failure which can be deemed to have been avoided if the periodic inspection described in the User's manual, etc. or the maintenance or replacement of consumable parts has been performed normally.
- ▶ The component is used for purposes other than the product's intended use.
- ▶ Failure or malfunction due to causes that could not be foreseen by our level of science and technology at the time of shipment.
- ▶ The fault is due to an external factor that is not our responsibility, such as natural disaster or disaster.



### Disclaimer

- ▶ The warranty will not cover secondary damage (damage to equipment, loss of opportunity, loss of profit, etc.) or any other damage caused by the failure of our product.
- ▶ Although we strive to improve the quality and reliability of our products, we do not guarantee their integrity. Especially when using this product for equipment that may infringe human life, body or property, take appropriate safety design measures, etc., with full consideration of problems that may normally occur. We assume no responsibility for such use if we have not obtained our consent in advance in writing of specifications, etc.
- ▶ Please observe the product specifications and precautions when using our products. We shall not assume any responsibility for any damage to the customer caused by the customer's negligence. However, this does not apply to damage caused by a defect in our product.



**2. Safety Instructions**



**Unpacking, Transportation and Storage**

 <b>Warning</b>	
 <b>Forcing</b>	<p><b>Serious injury can result.</b></p> <ul style="list-style-type: none"> <li>▶ When hanging or slinging a valve, pay sufficient attention to safety, and do not enter under the load.</li> </ul> <p><b>The valve can be damaged, or leak.</b></p> <ul style="list-style-type: none"> <li>▶ Do not subject the product to impact by throwing, dropping or hitting. (risk of damage or breakage)</li> </ul>

 <b>Caution</b>	
 <b>Prohibition</b>	<p><b>The valve can be damaged, or leak.</b></p> <ul style="list-style-type: none"> <li>▶ Do not scratch or pierce the product with a sharp object such as a knife or hand hook.</li> <li>▶ Do not pile up cardboard boxes forcefully to prevent the load from collapsing.</li> <li>▶ Avoid contact with coal tar, creosote (a wood preservative), white pesticides, insecticides, paints, etc.</li> <li>▶ Do not hang the handle when transporting the valve.</li> <li>▶ Keep in cardboard until just before piping, and store indoors (at room temperature) away from direct sunlight. Also, avoid storing the product in places of high temperature. (The strength of cardboard packaging decreases when it gets wet. Be very careful when storing and handling it.)</li> </ul>
 <b>Forcing</b>	<p><b>The valve can be damaged, or leak.</b></p> <ul style="list-style-type: none"> <li>▶ After unpacking, make sure that the product is correct and that it meets the specifications.</li> </ul>

**Product Handling**

 <b>Warning</b>	
 <b>Forcing</b>	<p><b>Serious injury can result.</b></p> <ul style="list-style-type: none"> <li>▶ If positive pressure gas is used for our resin piping material, a dangerous condition may occur due to the repulsive force peculiar to compressible fluids even if the pressure is the same as the water pressure. Therefore, be sure to take safety measures for the surrounding area, such as covering the piping with protective materials. Please inquire at the bank counter of Money if you have any questions. When conducting a leak test of a pipe line after completion of piping construction, check with water pressure. Contact us in advance if you are unavoidable to test with a gas.</li> </ul>

 <b>Caution</b>	
 <b>Prohibition</b>	<p><b>The valve can be damaged, or leak.</b></p> <ul style="list-style-type: none"> <li>▶ Do not step on the valve or place heavy objects on it. (risk of damage)</li> <li>▶ Keep away from fire and hot objects. (There is a risk of deformation, damage or fire.)</li> </ul>
 <b>Forcing</b>	<p><b>The valve can be damaged, or leak.</b></p> <ul style="list-style-type: none"> <li>▶ Keep the operating temperature and pressure within the allowable range. (The maximum allowable pressure includes water hammer pressure. The valve may be damaged if it is used outside the allowable range.)</li> </ul> <p><b>There is a danger of injury.</b></p> <ul style="list-style-type: none"> <li>▶ Allow sufficient space for maintenance and inspection.</li> </ul> <p><b>The valve can be damaged, or leak.</b></p> <ul style="list-style-type: none"> <li>▶ Select and use an appropriate material. (Components could be damaged due to the type of chemical. Contact us in advance for details.)</li> <li>▶ Use the product under conditions that do not recrystallize in fluids containing crystalline substances. (The valve will not operate normally.)</li> <li>▶ Avoid any place where water or dust is constantly splashed or where the product is exposed to direct sunlight, or provide a cover or the like to cover the entire area. (The valve will not operate normally.)</li> <li>▶ Perform periodic maintenance. (Leakage may occur due to changes in temperature or aging during long-term storage, resting, or use.)</li> <li>▶ If internal leakage occurs when the valve is fully closed, adjust the stopper.</li> <li>▶ The tightening bolts and nuts of the diaphragm (between the bonnet and body) may become loose due to changes in temperature or creep during storage or use. After checking, tighten the bolts and nuts diagonally to the values listed in the bonnet tightening torque table.</li> </ul>

## 3. Name of each part

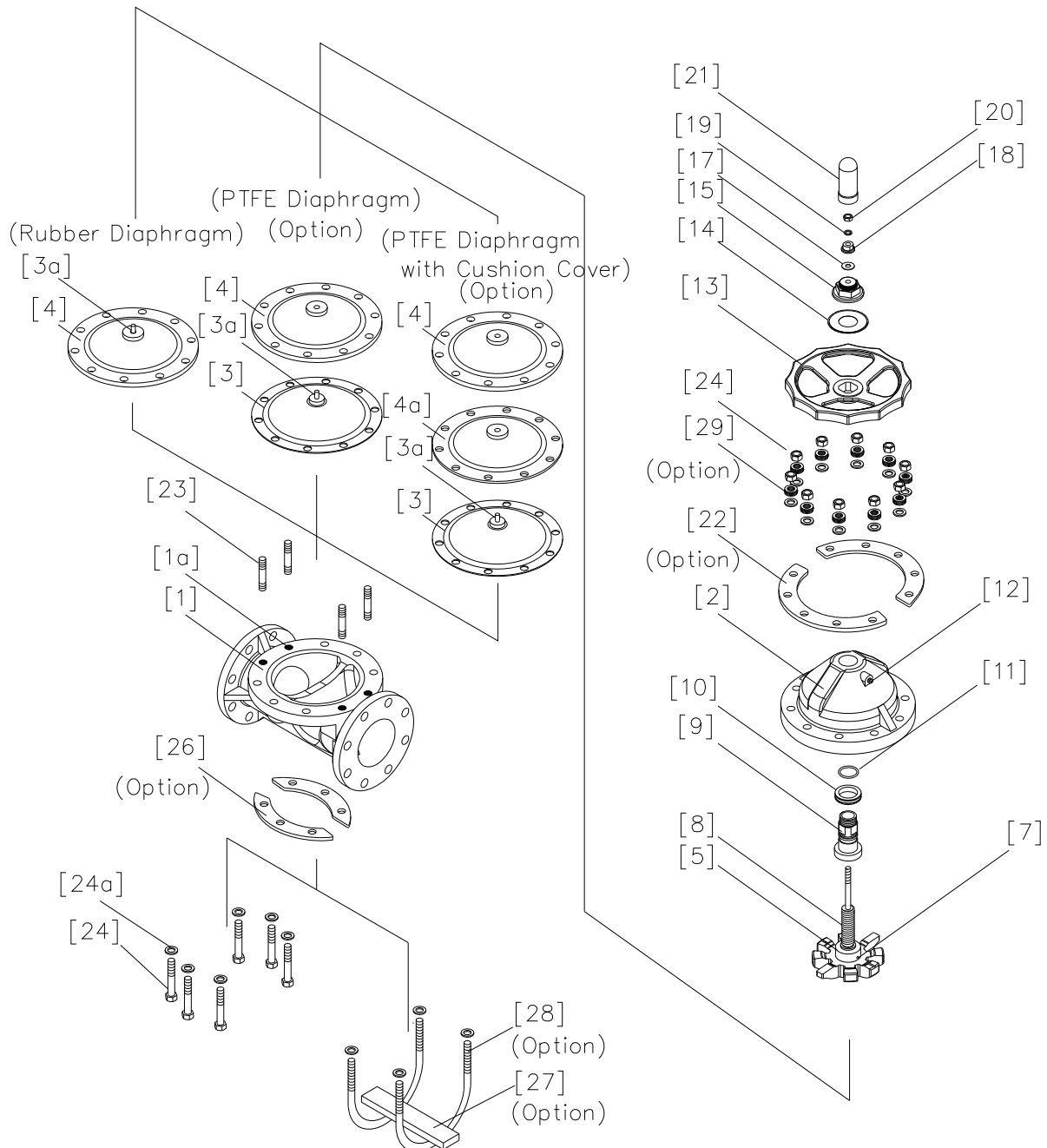

[1]	Body	[9]	Sleeve (A)	[20]	Set nut
[1a]	Inserted nut	[10]	Thrust bearing (A)	[21]	Gauge cover
[2]	Bonnet	[11]	O-ring (A)	[22]	Bonnet liner
[3]	Diaphragm	[12]	Grease nipple	[23]	Stud bolt and nut
[3a]	Inserted metal of Diaphragm	[13]	Handle	[24]	Bolts and nuts
[4]	Cushion	[14]	Name plate	[26]	Body liner
[4a]	Cushion cover	[15]	Cap	[27]	Rib liner
[5]	Compressor	[17]	Valve seat	[28]	U-bolt and nut
[7]	Compressor pin	[18]	Stopper	[29]	Disc spring washer
[8]	Stem	[19]	Spring Washer		

With limit switch (optional)

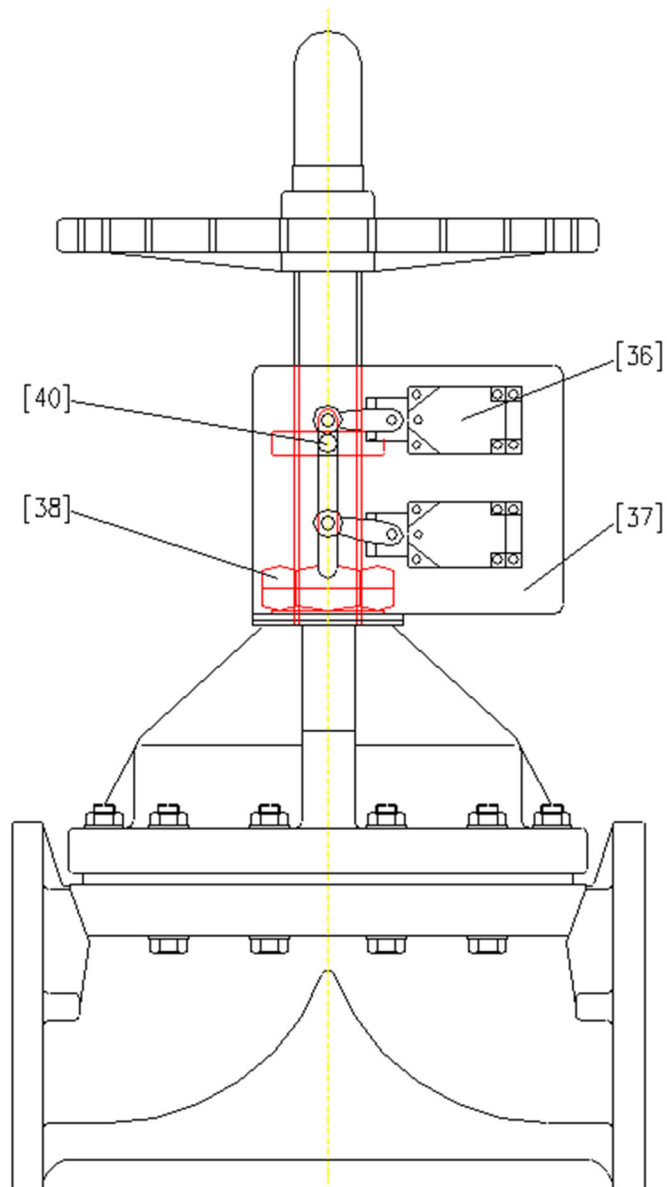

[36]	Limit switch	[38]	Nut (A)
[37]	Bracket (A)	[40]	Limit switch retainer



## 4. Product Specifications

### Model number table

ACTUATION	TYPE	OPERATING SYSTEM	BODY MATERIAL	SEAL MATERIAL	CONNECTION	STANDARD	SIZE	HIGH PURITY SERIES
V	15	MH	*	*	F	*	***	1
<b>V</b> MANUAL VALVE	<b>15</b> TYPE 15	<b>MH</b> ROUND HANDLE	<b>U</b> PVC <b>P</b> PP <b>F</b> PVDF <b>G</b> PVDF+PPG	<b>E</b> EPDM <b>V</b> FKM <b>T</b> PTFE	<b>F</b> FLANGED	<b>J</b> JIS 10K <b>5</b> JIS 5K <b>D</b> DIN <b>A</b> ANSI	<b>125</b> 125mm <b>150</b> 150mm	<b>1</b> LIBRICANT FREE

## Relationship between maximum allowable pressure and temperature

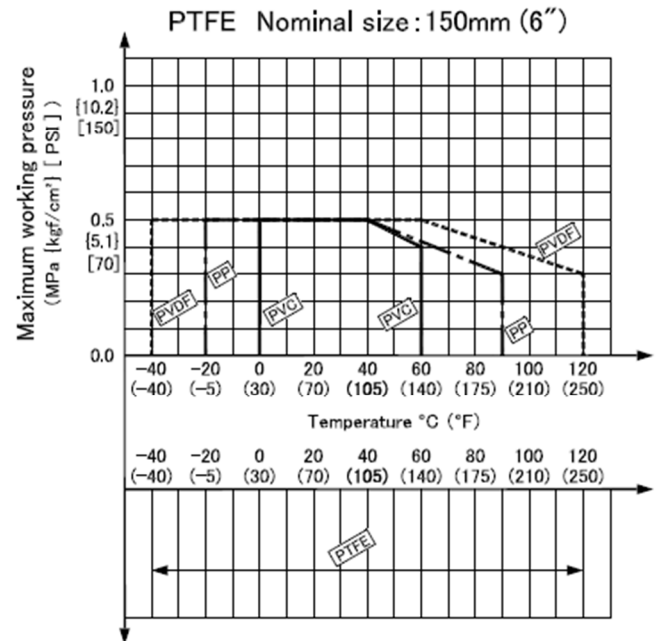
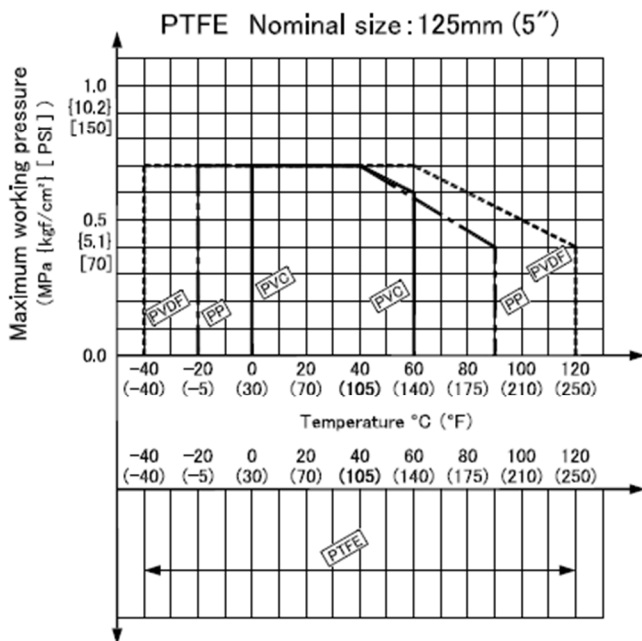
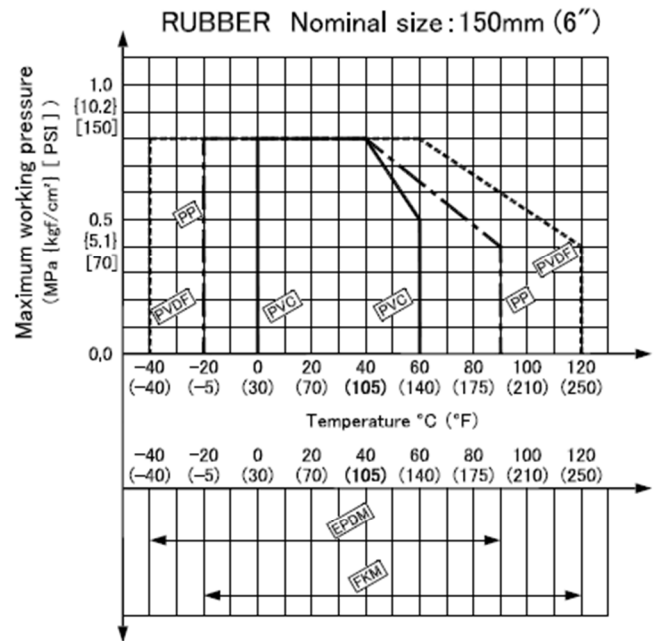
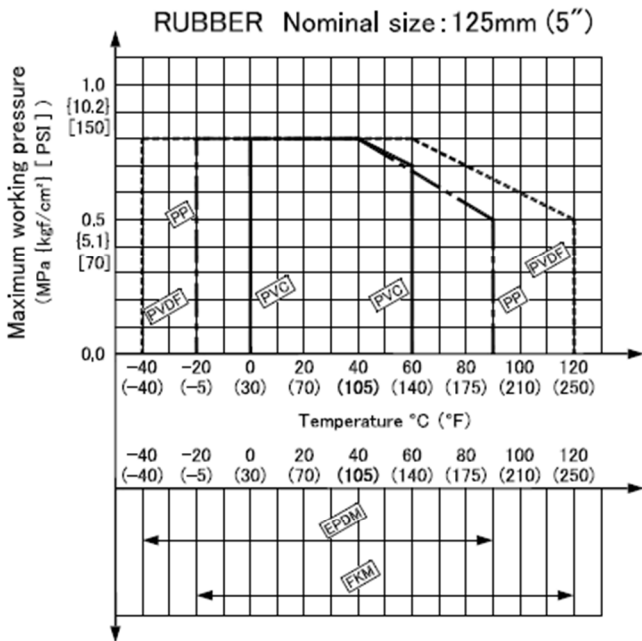

## Limit switch specifications

Size (mm)	Model	Protection grade
125, 150	1LS1-J	IP67

## Limit switch rating



Rated voltage	Resistance load (A)	Induction load (A)
125VAC	10	6
250VAC	10	6
115VDC	0.8	0.2
230VDC	0.4	0.1

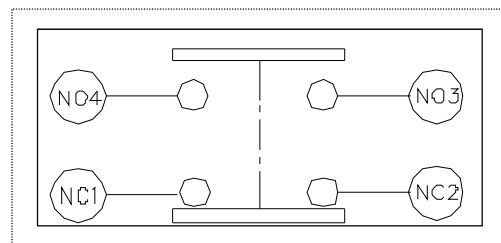

## Internal circuit



**5. Piping method**

**Flanged end**

 <b>Warning</b>	
 <b>Prohibition</b>	<p><b>Serious injury can result.</b></p> <ul style="list-style-type: none"> <li>▶ When hanging or slinging the valve, pay careful attention to safety and do not stand under the load.</li> <li>▶ Be sure to perform safety inspections of the machine tool and power tool beforehand.</li> </ul>

 <b>Caution</b>	
 <b>Prohibition</b>	<p><b>The valve can be damaged or leak.</b></p> <ul style="list-style-type: none"> <li>▶ Be careful not to overtighten the pipe support when you remove it with a U band or the like.</li> <li>▶ When installing the product, make sure that no excessive stress such as tension, compression, bending or impact is applied to the piping or valve.</li> <li>▶ When connecting a resin valve to metal piping, be careful not to apply piping stress to the resin valve.</li> </ul>
 <b>Forcing</b>	<p><b>The valve can be damaged or leak.</b></p> <ul style="list-style-type: none"> <li>▶ Use a connection flange with a full-face seat.</li> <li>▶ Check that there is no difference in mutual flange standards.</li> <li>▶ Be sure to use the sealing gaskets (AV gasket), bolts/nuts and washers to tighten them with the specified tightening torques. (The tightening torque will change if the gasket is not a AV gasket.)</li> </ul>

Preparations : ▶ Torque Wrench                      ▶ AV gasket

**[Procedure]**

- 1) Set packing between flanges.
- 2) Insert the washer and bolt from the connecting flange side, insert the washer and nut from the valve side, and tighten temporarily by hand.

<b>Caution</b>	
<b>Prohibition</b>	<p><b>The valve can be damaged or leak.</b></p> <ul style="list-style-type: none"> <li>▶ Keep the parallelism of the flange surface and the dimension of the shaft misalignment below the values shown below.</li> </ul>

Size (mm)	Axial misalignment	Parallelism (a-b)
125,150	1.0mm	1.0mm

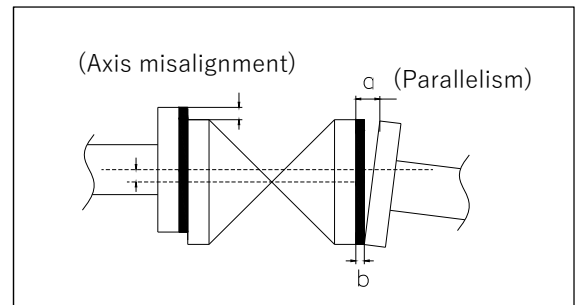

- 3) Gradually tighten to the specified flange tightening torque value diagonally (see Fig. 1) with a torque wrench.

<b>Caution</b>	
<b>Prohibition</b>	<p><b>The valve can be damaged or leak.</b></p> <ul style="list-style-type: none"> <li>▶ Tighten the bolts and nuts of the connection flange diagonally to the specified torque value. (risk of leakage or damage)</li> </ul>

Fig -1

Flange tightening torque units		N-m
SIZE (mm)	125	150
Torque value	40.0	40.0

**6. Limit switch wiring method**

<b>⚠ Warning</b>	
<b>⊘ Prohibition</b>	<b>Serious injury can result.</b> ▶ Do not connect or separate lines to the limit switch in the electric power state.

<b>⚠ Caution</b>	
<b>⊘ Prohibition</b>	<b>The valve can be damaged or leak.</b> ▶ Do not leave or use with the cover open. (Water or dust may penetrate and cause operation failure.) ▶ Contact CKD when using the limit switch in a 1mA~100mA, 5V~30V.

Preparations	▶ Phillips screwdriver ▶ Compression terminal ▶ Terminal crimping tool	▶ connector (G1/2) ▶ Wire stripper
--------------	--	---------------------------------------

**[Procedure]**

- 1) Phillips the screws (three) holding the limit switch cover.  
 Loosen with a screwdriver and remove the cover.  
 (The screws are structured so that they do not come off the cover.)
- 2) Pull off the resin protective cap.
- 3) Pass the cable through the connector.
- 4) Peel off the outer skin of the cable with a wire stripper.
- 5) Use a terminal crimping tool to attach the crimping terminal to the lead wire.
- 6) Wire the terminal screws with a Phillips screwdriver according to the internal circuit diagram on page 7.  
 \* Tighten the screws securely.
- 7) Tighten the three screws holding the limit switch cover with a Phillips screwdriver to attach the cover.
- 8) Tighten the cable with the connector.

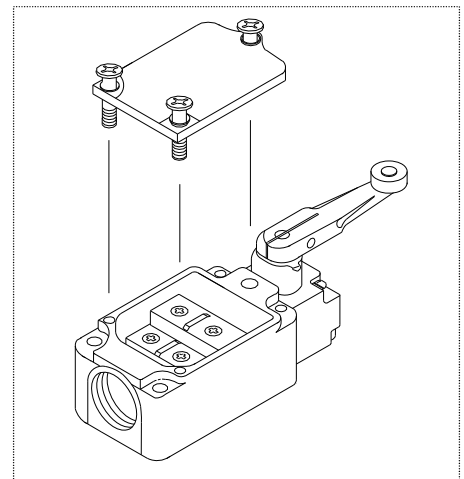

**7. Operation method**

**⚠ Caution**



**Prohibition**

**The valve can be damaged or leak.**

- ▶ Do not turn the handle unnecessarily with excessive force when fully closing or opening the valve.
- ▶ Do not open or close the valve with dust or other foreign matter in the fluid.
- ▶ Sand and other foreign matter may remain in the pipeline even after the valve is installed.  
Open and close the valve after cleaning the inside of the piping.
- ▶ Handle operation must be done by hand. (Use of equipment may cause damage.)
- ▶ Be sure to pass water before opening/closing the oil-prohibited parts.
- ▶ If the stopper is loose, adjust the stopper.

○ Turn gently to open/close operation.



(Clockwise to close-handle display S, counterclockwise to open-handle display O)

When fully closed: When the bottom surface of the stopper and the top surface of the cap are in close contact.

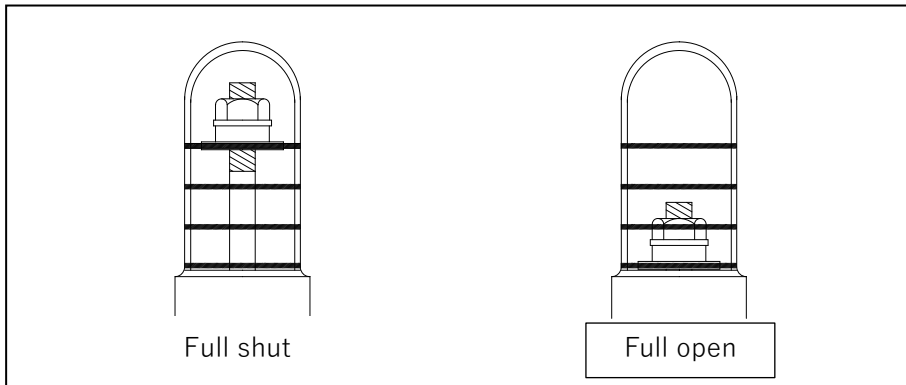
At full open position: When the blue line at the top of the gauge cover matches the red line of the stopper.



**8. How to disassemble/assemble parts for replacement**

 <b>Warning</b>	
 <b>Prohibition</b>	<p><b>Serious injury can result.</b></p> <ul style="list-style-type: none"> <li>▶ Be sure to perform safety inspections of the machine tool and power tool beforehand.</li> <li>▶ Wear appropriate protective equipment for the work details when installing piping.</li> </ul> <p><b>Serious injury, damage to the valve, or leakage can occur.</b></p> <ul style="list-style-type: none"> <li>▶ Completely drain the fluid in the piping when replacing the valve or replacing parts. If the fluid does not escape, reduce the fluid pressure to zero.</li> </ul>

Preparations	▶ Torque Wrench	▶ Spanner (2 pcs.)
	▶ Protective gloves	▶ Protective goggles

**[Procedure]**

- 1) Completely loosen bolts and nuts [24] between body [1] and bonnet [2].
- 2) Remove the bonnet section.
- 3) Turn hand wheel [13] until valve is fully closed.  
(It may be difficult to work when fully opened)
- 4) Remove the diaphragm [3] by rotating it counterclockwise (to the left).
- 5) Install the new diaphragm [3] in reverse order of step 4).  
Match the material indicator part of the diaphragm [3] (and cushion [4]) with the rib part (valve seat direction) of the bonnet [2].  
Also, check if the diaphragm embedded bracket [3a] is screwed in completely.  
(If the connection is incomplete, it may become impossible to open and close.)
- 6) Attach bonnet [2] to body [1].
- 7) Turn handle [13] one turn in the opening direction.
- 8) Tighten the bolts and nuts [24] between the body [1] and bonnet [2] diagonally to the specified torque value with a torque wrench. (Refer to the table below.)

Bonnet tightening torque value

Units; N-m

	Size	125mm, 150mm
Diaphragm		
	Rubber	45.0
	PTFE	45.0

- 9) Adjust the stopper.



**9. How to adjust the stopper**

**⚠ Caution**



**Prohibition**

**The valve can be damaged or leak.**

- ▶ If the stopper is loose or internal leakage occurs when the valve is fully closed, the stopper may not be functioning. Adjust the stopper.
- ▶ Tighten the stopper securely. (If the tightening torque of the stopper is weak, the stopper may become loose.)

Preparations ▶ Wrench ▶ Protective gloves and goggles

**[Procedure]**

- 1) Fully open valve.
- 2) Remove gauge cover [21].
- 3) Loosen stopper [18] and set nut [20].
- 4) Tighten the handle [13] gradually and stop at a position where liquid leakage stops.
- 5) Screw the stopper [18] to the stationary position of the handle and return it half a turn from that position.
- 6) Screw in the spring washer [19] and the set nut [20], and tighten the set nut [20] with the specified torque while securing it with the wrench. (Refer to the table below.)
- 7) Install gauge cover [21].

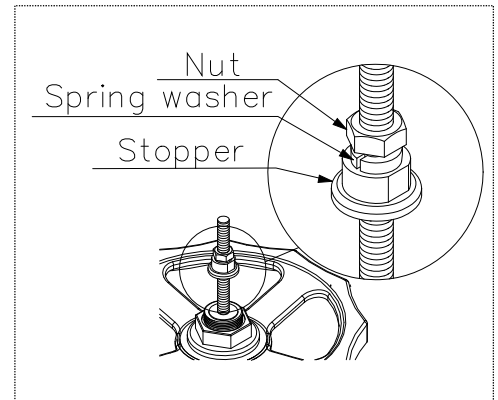



Set nut tightening torque value

Units: N-m

SIZE (mm)	125, 150
Torque value	10

**10. Inspection item**

 <b>Caution</b>	
 <b>Forcing</b>	<p><b>The valve can be damaged, or leak.</b></p> <ul style="list-style-type: none"> <li>▶ Maintenance should be performed every 3 to 6 months as a guide in order to keep the watch in normal condition and use it for a long time. Pay particular attention to temperature changes and aging during long-term storage or shutdown or use.</li> <li>▶ When removing the valve from the piping when replacing the valve or parts, completely remove the fluid from the piping before starting work.</li> <li>▶ If any trouble is found, take the appropriate action referring to "11. Cause of malfunction and remedy".</li> </ul>

**Daily inspection**

Inspection items and inspection methods	Guideline of judgment	Check point	Treatment method
External leakage (visual inspection)	No leakage	Pipe flange connection	① Retighten the pipe bolts to the specified torque. ② Remove the valve from the pipe and retighten the pipe bolts. <a href="#">(Ref: 5. Piping method)</a>
		Surface of the entire valve	Remove the valve from the pipe and replace the valve. <a href="#">(Ref: 8. How to disassemble/assemble parts for replacement)</a>
Internal leakage (visual and measurement)	No leakage	Leakage to secondary side when valve is fully closed	Remove the valve from the piping and replace the valve or defective part. <a href="#">(Ref: 8. How to disassemble/assemble parts for replacement)</a>
		Measured values of flowmeters, pressure gauges, etc.	Remove the valve from the piping and replace the valve or defective part. <a href="#">(Ref: 8. How to disassemble/assemble parts for replacement)</a>
Abnormal noise (hearing)	No abnormal noise	Valves	Remove the valve from the pipe and replace the valve. <a href="#">(Ref: 8. How to disassemble/assemble parts for replacement)</a>
		Piping around the valve	Reconfirm the conditions of use <a href="#">(Ref: 2. Safety Instructions)</a>

**Periodic inspection**

**●Guideline for the inspection cycle: 3 months**

Inspection items and inspection methods	Guideline of judgment	Check point	Remedy for malfunctions
Vibration (palpation)	No difference from other parts	Valve	Recheck the operating conditions and remove the source of vibration. <a href="#">(Ref: 2. Safety Instructions)</a>
		Piping around the valve	Recheck the operating conditions and remove the source of vibration. <a href="#">(Ref: 2. Safety Instructions)</a>

**Periodic inspection**

**●Guideline of the inspection cycle: 6 months**

Inspection items and inspection methods	Guideline of judgment	Check point	Remedy for malfunctions
Operability of manual handle (touch)	Rotates smoothly	Manual operation unit	Remove the valve from the pipe and replace the valve.
Looseness of bolts (visual and palpation)	No Loose	Between body and bonnet	Retighten the mounting bolts with the specified torque value for bonnet tightening. <a href="#">(Ref: 8. How to disassemble/assemble parts for replacement)</a>
		[Flange type] For flange piping	Retighten the pipe bolts to the specified torque. <a href="#">(Ref: 5. Piping method)</a>
Corrosion Or rust (visual inspection)	No corrosion or rust	Appearance of the product	Remove the valve from the pipe and replace the valve.
Product damage	No scratches, cracks, or deformation	Appearance of the product	Remove the valve from the pipe and replace the valve.

**11. Cause of malfunction and remedy**

 **Caution**

 **Forcing**



**There is a danger of injury.**

- ▶ If any malfunction is found, immediately stop using the product and take appropriate action.
- ▶ When removing the valve from the piping when replacing the valve or parts, completely remove the fluid from the piping before starting work.

Failure phenomenon	Possible cause	Measures and measures
Handle does not turn (cannot turn)	The valve is already fully open (or fully closed).	Rotate the hex wrench in the reverse direction ( <a href="#">Ref. 7. Operation method</a> )
	Foreign matter caught in valve	Remove the valve from the piping, disassemble it, and remove foreign matter.
	Piping stress is applied to the valve.	Remove the piping stress
	The torque of the valve has increased due to the effects of the fluid (temperature, components, pressure, etc.)	Reconfirm the conditions of use ( <a href="#">Ref: 2. Safety Instructions</a> )
Idle steering wheel	The diaphragm or stem is damaged.	Remove the valve from the pipe, disassemble it, replace the relevant part, or replace the valve. ( <a href="#">Ref: 8. How to disassemble/assemble parts for replacement</a> )
Fluid leaks even when fully closed (internal leak)	High fluid pressure	Use below the maximum allowable pressure ( <a href="#">Ref: 2. Safety Instructions</a> )
	The body or diaphragm is damaged.	Remove the valve from the piping, replace the relevant part, or replace the valve.
	Foreign matter caught in valve	Remove the valve from the piping, disassemble it, and remove foreign matter.
	Piping stress is applied to the valve.	Remove the piping stress
	The part is damaged.	Remove the valve from the piping, replace the relevant part, or replace the valve.
	Adjustment stopper is running	Adjust the stopper ( <a href="#">Ref: 9. How to adjust the stopper</a> )

Failure phenomenon	Possible cause	Measures and measures
Fluid leaks from valve (external leak)	Valve is cracked or broken	Stop using the product immediately, remove the valve from the piping, and replace the valve.
	Bonnet tightening bolt is loose	Retighten the mounting bolts with the specified torque value for bonnet tightening. <a href="#">(Ref: 8. How to disassemble/assemble parts for replacement)</a>
	The diaphragm is damaged.	Stop using the valve immediately. Remove the valve from the piping and replace the diaphragm or valve. <a href="#">(Ref: 8. How to disassemble/assemble parts for replacement)</a>
	O-ring is scratched, worn, melted, or altered	Stop using the product immediately, remove the valve from the piping, replace the relevant part, or replace the valve.
	Scratches or wear are found on the sliding or fixing surfaces of the O-ring.	Stop using the product immediately, remove the valve from the piping, replace the relevant part, or replace the valve.
Valve is corroded or deformed	The watch is exposed to water, chemical liquids, or other liquids.	Stop using the product immediately, remove the valve from the piping, and replace the valve. <a href="#">(Ref: 8. How to disassemble/assemble parts for replacement)</a>

**12. Disposal method of residual materials and waste materials**

 <b>Warning</b>	
 <b>Forcing</b>	<p><b>Serious injury can result</b></p> <p>▶ When disposing of the waste, please dispose of it according to the guidelines of the local authorities. (When burnt, toxic gas is generated)</p>

**Inquiries**

Contact the nearest distributor, our sales office, or our web website for inquiries about this product.

**[User's Manual]**

Diaphragm valve type 15  
(Manual type)



<https://www.asahi-yukizai.co.jp/en>

Please note that the content of this manual is subject to change without notice.

**March 2024**